

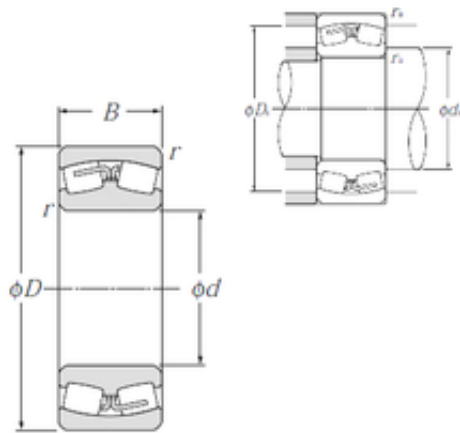

BEARING FORGE OF AMERICA CORP.

23072B NTN Spherical Roller Bearings



Bearing No. 23072B

Size	360x540x134 mm
Bore Diameter	360 mm
Outer Diameter	540 mm
Width	134 mm
d	360 mm
D	540 mm
B	134 mm
C	134 mm
r min.	5 mm
da min.	382 mm
Da max.	518 mm
ra max.	4 mm
Weight	110 Kg
Basic dynamic load rating (C)	2 370 kN
Basic static load rating (C0)	4 700 kN
(Grease) Lubrication Speed	590 r/min
(Oil) Lubrication Speed	770 r/min
Calculation factor (e)	0,24
Calculation factor (Y0)	2,72
Calculation factor (Y1)	2,78
Category	Bearings
Inventory	0.0
Manufacturer Name	NTN
Minimum Buy Quantity	N/A
Weight / Kilogram	119
Product Group	B04311

23072B Bearing 2D drawings and 3D CAD models



BEARING FORGE OF AMERICA CORP.